

MY KIND OF  
KITCHEN



KITCHENS

2018

# CRAFTED WITH CARE

---

*Choosing a beautiful new kitchen is an exciting experience. After all, it's a chance to put a little bit of your own personality into one of the most important rooms in your home...*

---

Milano by Symphony offers the latest innovative ideas in kitchen style manufactured here at home in Britain.

The good news is there are plenty of fabulous styles to choose from in the Kitchen Collection from time-honoured classic painted designs to a more adventurous high gloss contemporary look.

Enjoy browsing all of our finishing touches such as handles and work surfaces to complete your kitchen design.

Plus clever use of must have accessories like lighting and storage solutions will bring your kitchen to life.

---



# CONTENTS

---

## CONTEMPORARY

---

NEW YORK PAINT TO ORDER	08-12
NEW YORK GLOSS & MATT	13-16
ALTA GLOSS	17-20
ALTA MATT	21-23
ALTA PAINT TO ORDER	24-25
WOODBURY	26-31
QUADRA	32-35
PLAZA	36-40
MINNESOTA	41-42
KANSAS	43-44
VIRGINIA	45-46

## CLASSIC

---

NEW ENGLAND	50-53
WEXFORD	54-55
STAMFORD	56-57
AUSTIN	58-61
OAKHAM	62-63
ASHBOURNE	64-65
CRANBROOK	66-71
ROCKFORT	72-73
NEWPORT	74-75

## FINISHING TOUCHES

---

HANDLES	78-81
WORK SURFACES	82-83
GLASS SPLASHBACKS & UPSTANDS	84-85
LED LIGHTING & ELECTRICAL ACCESSORIES	86-87
KESSEBOHMER PREMIUM	88-89
DRAWER SOLUTIONS	90-92
WASTE DISPOSAL	93

## SPECIFICATION

---

CABINET SPECIFICATION	96-97
ABOUT SYMPHONY	98



*Creating the present...*



# CONTEMPORARY

---

*Milano offers the latest in kitchen design.  
From stunning gloss, to the latest timber effect  
finishes, a contemporary kitchen from Milano  
will be a real design masterpiece.*

# CONTEMPORARY

---

*From subtle textures and woodgrain effect doors, to smooth painted matt doors and high gloss doors, our contemporary range of kitchens can be used to create a distinctive look.*

*Choose from a single range throughout your kitchen, or why not be more adventurous and use a contrasting woodgrain finish?*

*The contrasting tones within the same kitchen can create an ultra modern kitchen design.*

*Use our feature open accent cabinets in yellow or blue to inject a burst of colour, or why not choose one of our woodgrain options for a subtle, but still unique, option for your kitchen?*

*Add your own individual twist by selecting from our range of work surfaces, glass splashbacks and handle options.*

*Accentuate dark tones by using copper for your handles and a metallic coloured splashback, or for a more subtle look use a nickel or stainless steel handle paired with a lighter worktop colour such as Alaska and a matching laminate splashback.*

*With various on-trend colours and finishes to choose from you can make your kitchen a real statement.*

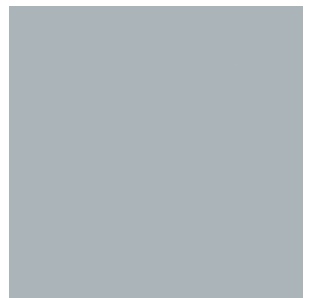
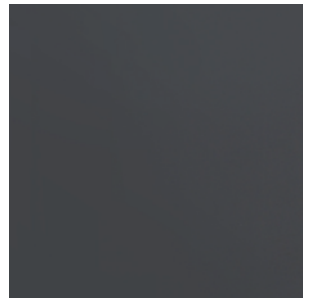
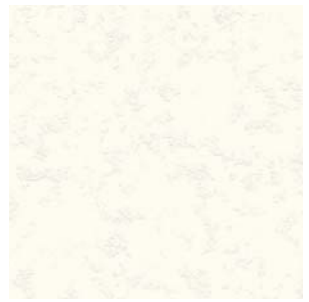





NEW YORK PAINTED  
COBBLE GREY & SNOW WHITE

*Shown with Glacier White Corian worktop  
and standard integrated handle*



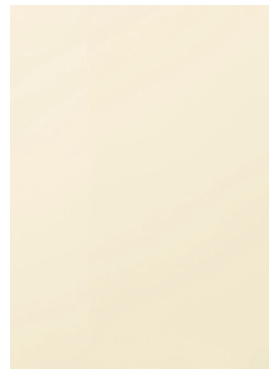

*Painted Ivory*



*Painted Ivory  
Glazed (Frosted Glass)*



*Painted  
Anthracite*



*Painted  
Cashmere*



*Painted  
Clay*



*Painted  
Cobble Grey*



*Painted  
Cooks Blue*



*Painted  
Dove Grey*



*Painted  
Duck Egg Blue*



*Painted  
Mussel*



*Painted  
Platinum*



*Painted  
Pumice*



*Painted  
Sage*



*Painted  
Skylon Grey*



*Painted  
Snow White*



*Painted  
Stone*

## NEW YORK PAINT TO ORDER

New York Paint to Order is a modern and elegant door featuring an integrated handle. With fifteen matt painted colours to choose from, New York is the perfect addition to any home.

PRICE BAND - 4



PAINTED COOKS BLUE



PAINTED CLAY

**Above:** Lift up bridging cabinets are used here to provide convenient storage above the sink.

**Left:** Create a sleek island design by using island end panels with the integrated handle to create clean lines throughout your kitchen.



NEW YORK GLOSS  
DUSK GREY & PEARL GREY

*Shown with Carrera Marble solid surface worktop and  
standard integrated handle*



*Gloss Cashmere*



*Gloss Cashmere Glazed  
(Frosted Glass)*



*Gloss Dusk Grey*



*Gloss Ivory*



*Gloss Pearl Grey*



*Gloss White*



*Matt Anthracite*

## NEW YORK

---

Add a touch of glamour to your home with the internationally inspired New York range. Its integrated handle provides beautiful clean lines to create an ultra modern kitchen. Available in five subtle gloss colours including the new Gloss Dusk grey and Gloss Pearl Grey as well as a new Matt Anthracite colour.

PRICE BAND - 4



NEW YORK MATT ANTHRACITE

*Shown with Quartz Marango Silestone worktop  
and standard integrated handle*





INLINE ALTA GLOSS DUSK GREY  
& PEARL GREY





*Gloss Mussel*



*Gloss Mussel Glazed  
(Frosted Glass)*



*Gloss Dusk Grey*

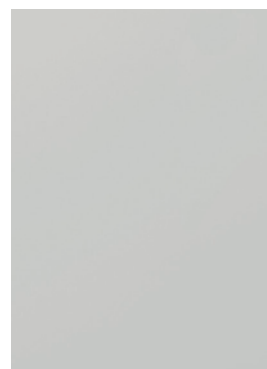

*Gloss Pearl Grey*



*Gloss Pure White*

## ALTA GLOSS

---

This high gloss door offers a contemporary feel that suits the most modern of kitchens. Available in four on-trend gloss colours.

PRICE BAND - 3



DUSK GREY & RUSTIC OAK



PURE WHITE

**Above:** With the designer glazed door of Alta Gloss you can create a stylish look with minimum effort. Try using the illuminated wall cabinet for that extra ‘wow’ factor.

**Left:** Why not mix it up a little and use one of our Alta timber effect frontals to make a statement in your kitchen. Rustic Oak can be selected with a matching 22mm laminate worktop.



ALTA MATT DARK WALNUT  
& PURE WHITE

*Shown with White Storm Silestone worktop  
and Brushed Nickel Barrel D handle - HPK630*



*Matt Anthracite*



*Matt Anthracite Glazed  
(Frosted Glass)*



*Matt Dark Walnut*



*Matt Rustic Oak*

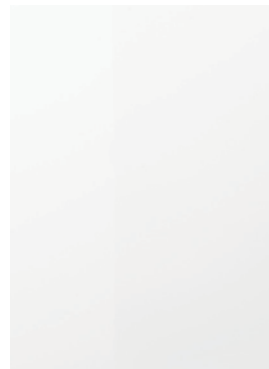

*Matt Pure White*

## ALTA MATT

---

With two on-trend smooth to touch matt colours and two subtly textured realistic timber effect finishes, Alta Matt can add a touch of individuality to your kitchen design.

PRICE BAND - 2



RUSTIC OAK



MATT ANTHRACITE  
& RUSTIC OAK

**Above:** Use different colours, textures and cabinet options to create a look that is suited to your taste.

**Left:** Using a worktop finish that matches your chosen door such as this Rustic Oak 22mm worktop can create an ultra modern co-ordinated style.



ALTA PAINTED SKYLON GREY

*Shown with Modern Bright Chrome  
Offset Bridge handle - HPK681*





*Painted Ivory*



*Painted Anthracite*



*Painted Cashmere*



*Painted Clay*



*Painted Cobble Grey*



*Painted Cooks Blue*



*Painted Dove Grey*



*Painted Duck Egg Blue*



*Painted Mussel*



*Painted Platinum*



*Painted Pumice*



*Painted Sage*



*Painted Skylon Grey*



*Painted Snow White*



*Painted Stone*

## ALTA PAINT TO ORDER

Alta Paint to Order is a sophisticated modern design. With a choice of fifteen matt painted colours, try mixing colours for a truly unique style.

PRICE BAND - 2



WOODBURY PLATINUM

*Shown with Alaska laminate worktops and  
Platinum & Chrome D handle - HPK695*

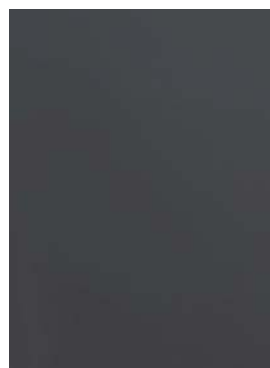

*Gloss Anthracite*



*Gloss Basalt*

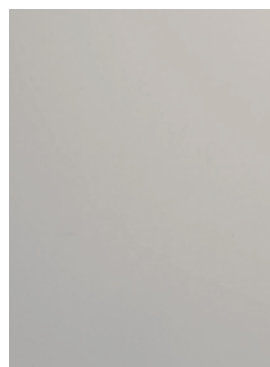

*Gloss Cashmere*

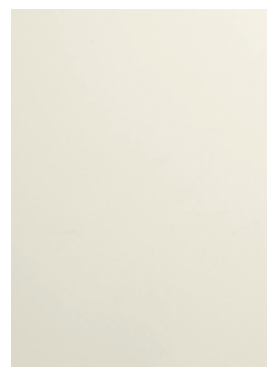

*Gloss Ivory*

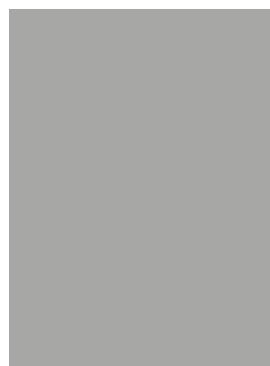

*Gloss Platinum*

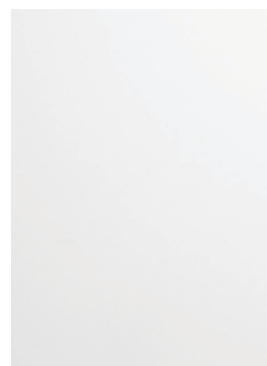

*Gloss White*

## WOODBURY

---

Woodbury is available in six gloss colours which can be mixed and matched with other kitchen ranges, to create an on-trend kitchen style.

PRICE BAND - 2



WOODBURY CASHMERE WITH  
BLUE ACCENT UNITS

*Shown with Volcanic Ash Premium worktop and  
Polished Chrome D handle - HPK448*





GLOSS ANTHRACITE  
WITH YELLOW ACCENT UNITS  
AND INLINE CHROME WAVE TRIM



BASALT

**Above:** Create a framed look with our on trend thin 22mm laminate worktops and matching framing panels.

**Left:** Using open accent cabinets in bright colours creates a focal point to your kitchen and allows you to be really creative with your design.



QUADRA PAVILION GREY

*Shown with Woodstone Premium worktop and  
Rialto Stainless Steel handle - HPK712*



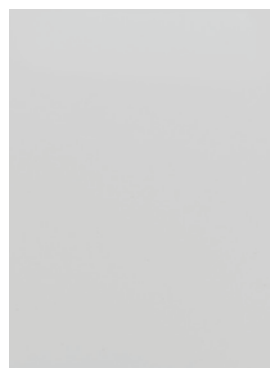

*White*



*Cobble Grey*



*Pavilion Grey*

## QUADRA

---

The raised frame profile of the Quadra door combines a contemporary feel with a classic look. Available in three smooth touch matt colours that deliver an ultra stylish kitchen.

PRICE BAND - 2



COBBLE GREY



COBBLE GREY

**Above:** Elongated slim handles accentuate the thin frame profile of the Quadra door.

**Left:** Floor to ceiling cabinets can provide a luxurious feel to the kitchen space.



PLAZA COBBLE GREY & PORCELAIN

*Shown with Pastel Oak Woodstone and  
Brushed Nickel Angle Bridge handle - HPK714*



*Cashmere*



*Cobble Grey*



*Mussel*

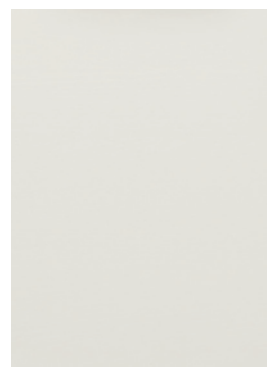

*Porcelain*



*Stone*

## PLAZA

---

Create a calm relaxed tone to the kitchen by choosing the textured finish of Plaza. Available in five beautiful colours - Cashmere, Cobble Grey, Mussel, Porcelain and Stone.

PRICE BAND - 0



COBBLE GREY & PORCELAIN



CASHMERE & PORCELAIN

**Above:** Why not add some stylish open accent cabinets to create a showcase for your favourite cook books and ornaments.

**Left:** Creating a personal look can be as simple as mixing two colours. Try using a contrasting colour to the wall cabinets on the base cabinets.



MINNESOTA  
& ALTA MATT PURE WHITE

*Shown with Turkish Marble worktop  
and Inline Aluminium Trim*





*Avola Grey*

## MINNESOTA

---

Shown here with Alta Inline Matt Pure White, the striking and modern look of Minnesota creates a centre-piece island design. Use the Inline Aluminium Trim to create an uncluttered linear style kitchen.

PRICE BAND - 0



KANSAS

*Shown with Dark Ash worktop and  
Matt Brushed Nickel Arched handle - HPK631*



*Light Ash*

## KANSAS

---

The textured cross-grained finish of the Kansas range offers a luxurious looking kitchen design. Shown here mixed with Woodbury Cashmere.

PRICE BAND - 0



VIRGINIA & ALTA MATT PURE WHITE

*Shown with 22mm Designer White worktop and  
Matt Nickel Square D handle – HPK644*



*Blonde Oak*

## VIRGINIA

---

A simple, yet elegant, Blonde Oak door, Virginia fuses the essence of sophistication with contemporary design. Shown here with Alta Matt Pure White.

PRICE BAND - 0



*Crafted with care...*

# CLASSIC

---

*Our Classic collection of versatile designs provide a range of truly striking kitchens - everything from simple shaker designs to timeless paint to order in-frame styles. These kitchens have been crafted for those who prefer the 'classical' approach to kitchen style.*

# CLASSIC

---

*This range of kitchens exude warmth and character to form a wonderful welcoming feel. From classic smooth shaker doors in subtle tones, to our painted ash veneered options available in several on-trend colours; you can create a country cottage style or a more sophisticated modern kitchen design.*

*Create a traditional look by using colours such as Clay, Ivory, Sage and Stone and mixing with an Oak work surface and aged brass handles. For a more modern look use Grey, White and Blue tones and select a chrome handle and contemporary work surface.*

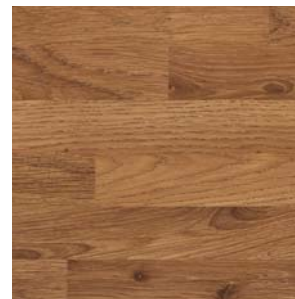







NEW ENGLAND PAINT TO ORDER  
BLACK & STONE

*Shown with Cashmere Grey Granite worktop and Vintage  
Nickel Pewter handle - HPK629*



*Painted Ivory*



*Painted Ivory Glazed  
(Clear Glass)*

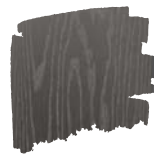

*Painted Anthracite*



*Painted Black*



*Painted Cashmere*



*Painted Chalk White*



*Painted Clay*



*Painted Cobble Grey*



*Painted Cooks Blue*



*Painted Dove Grey*



*Painted Duck Egg Blue*



*Painted Mussel*



*Painted Platinum*



*Painted Pumice*



*Painted Sage*



*Painted Skylon Grey*



*Painted Stone*

## NEW ENGLAND

Kitchens don't get any more traditional than New England. The in-frame design brings together classic craftsmanship and subtle detailing. New England is available in sixteen Paint to Order colours which can be paired in the kitchen to create a modern twist on a classic design.

PRICE BAND - 6



BLACK & CHALK WHITE



BLACK & CHALK WHITE

**Left:** Glazed dresser cabinets can add a touch of style to your kitchen and allow you to showcase glassware and key pieces.



WEXFORD CHALK WHITE & COBBLE GREY

*Shown with Carrara Marble and Solid Oak worktops  
and Stainless Steel Jupiter knob - HPK637*



*Painted Ivory*



*Painted Ivory Glazed  
(Clear Glass)*



*Painted Anthracite*



*Painted Black*



*Painted Cashmere*



*Painted Chalk White*



*Painted Clay*



*Painted Cobble Grey*



*Painted Cooks Blue*



*Painted Dove Grey*



*Painted Duck Egg Blue*



*Painted Mussel*



*Painted Platinum*



*Painted Pumice*



*Painted Sage*



*Painted Skylon Grey*



*Painted Stone*

## WEXFORD

The Wexford kitchen has a unique appeal that suits a range of styles. Its Paint to Order finish is available in sixteen colours and allows the creation of a gorgeous kitchen that fits a more traditional taste perfectly.

PRICE BAND - 5



STAMFORD

*Shown with Earthstone Pastel Melange worktop and  
Lamont Pewter D handle – HPK600*





*Character Oak*



*Character Oak Glazed  
(Gothic Bianco,  
Clear Glass)*

## STAMFORD

---

The burrs and knots of character oak lend a traditional rustic charm to the Stamford range.

PRICE BAND - 5



AUSTIN PAINT TO ORDER  
DUCK EGG BLUE & MUSSEL

*Shown with Natural Timber Heart Ash and Chrome  
Concave D handles - HPK607 and HPK608*



*Ivory*



*Ivory Glazed (Clear Glass)*



*Painted Anthracite*



*Painted Black*



*Painted Cashmere*



*Painted Chalk White*



*Painted Clay*



*Painted Cobble Grey*



*Painted Cooks Blue*



*Painted Dove Grey*



*Painted Duck Egg Blue*



*Painted Mussel*



*Painted Platinum*



*Painted Pumice*



*Painted Sage*



*Painted Skylon Grey*



*Painted Stone*

## AUSTIN

Inspired by the beauty of shaker design, Austin offers unadorned elegance to your kitchen. The painted timber sits at the heart of your home that will never go out of fashion. Available in the popular Ivory as well as fifteen Paint to Order colours.

AUSTIN IVORY PRICE BAND - 4

AUSTIN PAINT TO ORDER PRICE BAND - 5



STONE



PUMICE & CLAY

**Above & Left:** Something as simple as a handle choice can change the look of this door from a traditional look to a more contemporary.

**Above:** The appliances you choose can change the look of your kitchen. A modern design can be made more classic with a range cooker as shown here.



OAKHAM & AUSTIN  
PAINTED ANTHRACITE

*Shown with Silestone White Storm worktop  
and Brushed Nickel Barrel D handle HPK630*



*Blonde Oak*



*Blonde Oak Glazed  
(Clear Glass)*

## OAKHAM

---

Oakham is a shaker style with an elegant oak finish that brings an air of sophistication to any kitchen. Shown here in combination with Austin Painted Anthracite to give this design a fresh elegant look.

PRICE BAND - 4



ASHBOURNE IVORY & PAINT  
TO ORDER DUCK EGG BLUE

*Shown with Carrara Marble and Solid Oak worktops  
and Pewter Lamont D handle - HPK600  
Pewter Lamont Cup handle - HPK638*





*Ivory*



*Ivory Glazed (Clear Glass)*



*Painted Anthracite*



*Painted Black*



*Painted Cashmere*



*Painted Chalk White*



*Painted Clay*



*Painted Cobble Grey*



*Painted Cooks Blue*



*Painted Dove Grey*



*Painted Duck Egg Blue*



*Painted Mussel*



*Painted Platinum*



*Painted Pumice*



*Painted Sage*



*Painted Skylon Grey*



*Painted Stone*

## ASHBOURNE

The exquisite grain effect door creates a classic and sophisticated kitchen to suit everyone. With fifteen Paint to Order colours available, as well as Ivory, you can infuse subtle or more striking colours into your kitchen.

ASHBOURNE IVORY PRICE BAND - 2

ASHBOURNE PAINT TO ORDER PRICE BAND - 3



CRANBROOK SAGE & STONE

*Shown with Volcanic Ash premium worktop  
and Smoked Oak Yo-yo knob - HPK718*



*Platinum*



*Platinum Glazed  
(Clear Glass)*



*Cobble Grey*

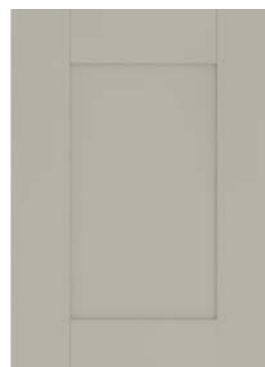

*Sage*



*Stone*

## CRANBROOK

Cranbrook is a stylish take on a timeless classic. Available in Cobble Grey, Platinum, Sage and Stone, it offers a muted palette that can be enhanced by mixing with gorgeous timber tones as shown here with the Volcanic Ash worktop and Smoked Oak Yo-Yo Knob handle.

CRANBROOK PRICE BAND - 2



CRANBROOK COBBLE GREY & PLATINUM

*Shown with Silestone Lyra worktop and Traditional Antique  
Copper knob & D handles - HPK784 & HPK785*





PLATINUM



SAGE

**Above:** Make a real centrepiece of the cooking space by having a traditional mantel over a luxurious range cooker.

**Left:** No classic cottage style kitchen can be complete without a Belfast sink.



ROCKFORT

*Shown with Solid Oak worktop and Natural Iron  
Fluted knob and backplate - HPK464*



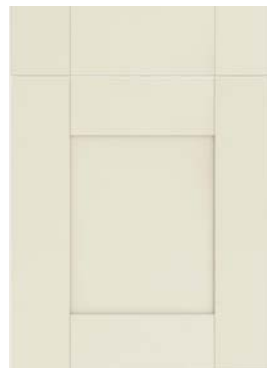

*Ivory*



*Ivory Glazed (Clear Glass)*

## ROCKFORT

---

With its simple beauty Rockfort has the versatility to offer a traditional or modern look. Modern accessories will offer a stylish finish, or choose traditional handles to offer a more classic style.

PRICE BAND - 1



NEWPORT

*Shown with Solid Timber Iroko worktop and  
Gothic D handle - HPK346*



*Ivory*



*Ivory Glazed  
(Planked Effect Frosted)*

## NEWPORT

---

The traditional qualities of Newport give it a cosy, homely feel. Each Ivory door features a distinctive tongue and groove centre panel to provide a beautiful timeless appeal.

PRICE BAND - 1



*It's all in the detail...*

# FINISHING TOUCHES

---

*You've chosen the style, you've decided the finish, now it's time to choose the finishing touches that make a new kitchen truly your own. Handles, lighting and storage accessories are the essential extras that not only enhance the beauty of your new furniture but also make it perfectly practical.*

# HANDLES

---

Our wide selection of handle options allows you create a unique look and feel that is personal to you.





*Iron D Handle*  
HPK330



*Gothic D Handle*  
HPK346



*Gloss White & Chrome Handle*  
HPK405



*Square Chrome Bar Handle*  
HPK434



*Gloss Ivory & Chrome Handle*  
HPK435



*Chrome Swept D Handle*  
HPK438



*Stainless Steel T Knob*  
*(not suitable for corner situations -*  
*excluding on In-Frame)*  
HPK440



*Stainless Steel Cup*  
HPK441

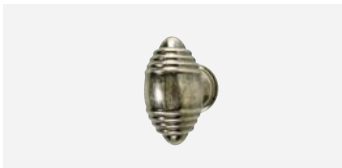

*Beehive Pewter Effect Knob*  
*(not suitable for corner situations -*  
*excluding on In-Frame)*  
HPK442



*Pewter Wave D Handle*  
HPK443



*Curve Box Polished*  
*Chrome Handle*  
HPK445



*Satin Nickel Wedge Handle*  
HPK446



*Satin Nickel Strap Handle*  
HPK447



*Polished Chrome D Handle*  
HPK448



*Asymmetric Chrome D Handle*  
HPK462



*Elongated Satin Nickel*  
*Bow Handle*  
HPK463



*Natural Iron Fluted Knob*  
*& Backplate*  
HPK464



*Satin Nickel Grooved Bow Handle*  
HPK465



*Nickel Arched D Handle*  
HPK472



*Gloss Cashmere & Chrome Handle*  
HPK489

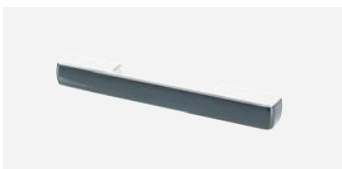

*Gloss Anthracite &*  
*Chrome Handle*  
HPK490



*Square Bar Polished*  
*Chrome Handle*  
HPK493 & HPK494



*Pewter Lamont D Handle*  
HPK600

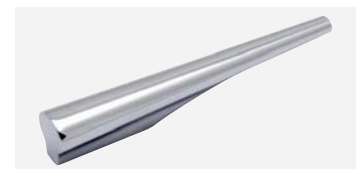

*Librè Bullet Handle*  
HPK606

# HANDLES

---



*Chrome Concave D Handle*  
HPK607



*Chrome Concave D Handle*  
HPK608



*Chrome Circular Handle*  
HPK609



*Vintage Nickel Handle*  
HPK629



*Stainless Steel Barrel D Handle*  
HPK630



*Matt Brushed Nickel Arch Handle*  
HPK631



*Square Chrome Bar Handle*  
HPK634

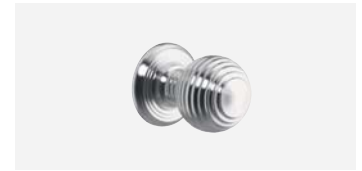

*Stainless Steel Jupiter Knob*  
HPK637



*Pewter Lamont Cup Handle*  
HPK638



*Chunky Chrome Bridge Handle*  
HPK640



*Chrome Square D Handle*  
HPK642



*Brushed Nickel Bow Handle*  
HPK643



*Matt Nickel Square 'D' Handle*  
HPK644



*Modern Bright Chrome Bridge Handle*  
HPK649



*Modern Bright Chrome Bridge Handle*  
HPK650



*Modern Nickel Handle*  
HPK651

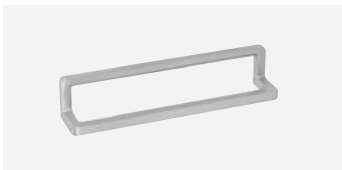

*Eight by Eight Nickel Handle*  
HPK652



*Grooved Pewter D Handle*  
HPK672

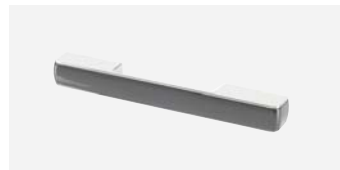

*Gloss Basalt & Chrome Handle*  
HPK673



*Chrome Satin & Nickel Handle*  
HPK674



*Modern Bright Chrome Offset Bridge Handle*  
HPK681



*Gloss Platinum & Chrome Handle*  
HPK695



*Rialto Stainless Steel Handle*  
HPK712



*Brushed Nickel Angle Bridge Handle*  
HPK714





*Smoked Oak Yo-Yo Knob*  
HPK718



*Satin Nickel Offset Bridge Handle*  
HPK719



*Satin Nickel Bridge Handle*  
HPK720



*Satin Nickel Bridge Handle*  
HPK721



*Oil Rubbed Bronze Knob*  
HPK723



*Brushed Brass Knob*  
HPK724



*Vintage Matt Black & Copper Bar Handle*  
HPK727



*Graphite Osaka Pull Handle*  
HPK728



*Graphite Osaka Pull Handle*  
HPK729



*Graphite Osaka Pull Handle*  
HPK730



*Copper Osaka Pull Handle*  
HPK731



*Copper Osaka Pull Handle*  
HPK732



*Copper Osaka Pull Handle*  
HPK733



*Patterned Gunmetal Bar Handle*  
HPK734 & HPK735



*Burbridge Brushed Brass D Handle*  
HPK736



*Aged Brass Effect Knob*  
HPK739



*Aged Brass Effect Cup Handle*  
HPK750



*Aged Copper Sulky D Handle*  
HPK751



*Traditional Chrome D Handle*  
HPK752



*Aged Brass Effect D Handle*  
HPK753



*Antique Copper D Handle*  
HPK754

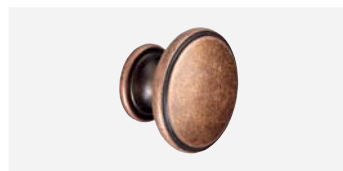

*Traditional Antique Copper Knob*  
HPK784



*Traditional Antique Copper D Handle*  
HPK785

# WORK SURFACES

---

Creativity doesn't have to stop with your furniture but can extend to your worktop. Durable with easy-clean technology, our range of work surfaces offer individuality in your kitchen.

## 22MM PVC-EDGED LAMINATE WORKTOPS

These stunning 22mm worktops feature subtle textured surfaces and are the cutting edge of laminate worktop design.



*Brazillia*

*Dark Oak*

*Designer White*

*Light Ash*

*Rustic Oak*

*Mystic Pine*

## 40MM POSTFORMED & PVC-EDGED LAMINATE WORKTOPS

Our 40mm worktops are supplied in a bullnose or PVC edged specification and are available with co-ordinating upstands and splashbacks.



*Alaska*

*Alpine White*

*Copper Slate*

*Dark Ash*

*Everest Black*

*Natural Ash*

*Oak Block*

*Pastel Oak*

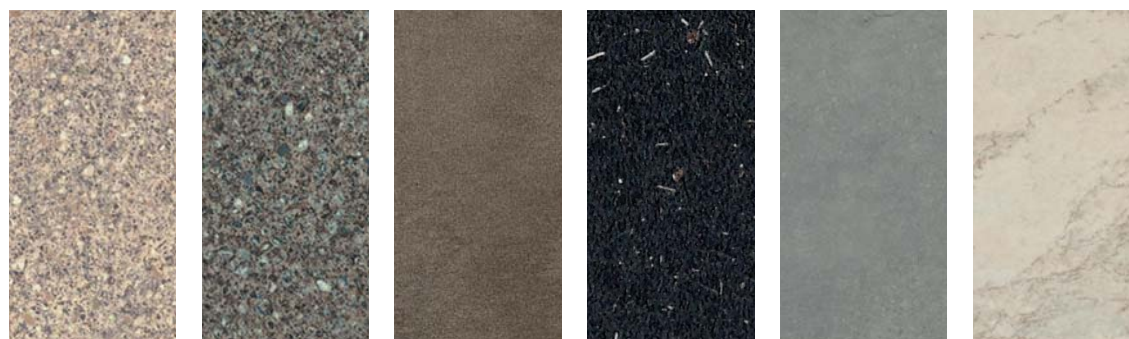

*Riverside Beige*

*Riverside Grey*

*Sandstone*

*Stella Mare*

*Tectonica*

*Turkish Marble*

Please note: Colour reproduction is as accurate as printing techniques allow.

## 40MM PREMIUM LAMINATE WORKTOPS

Our range of premium worktops have been developed to have a tighter radius of 3mm for a more contemporary look and feel.

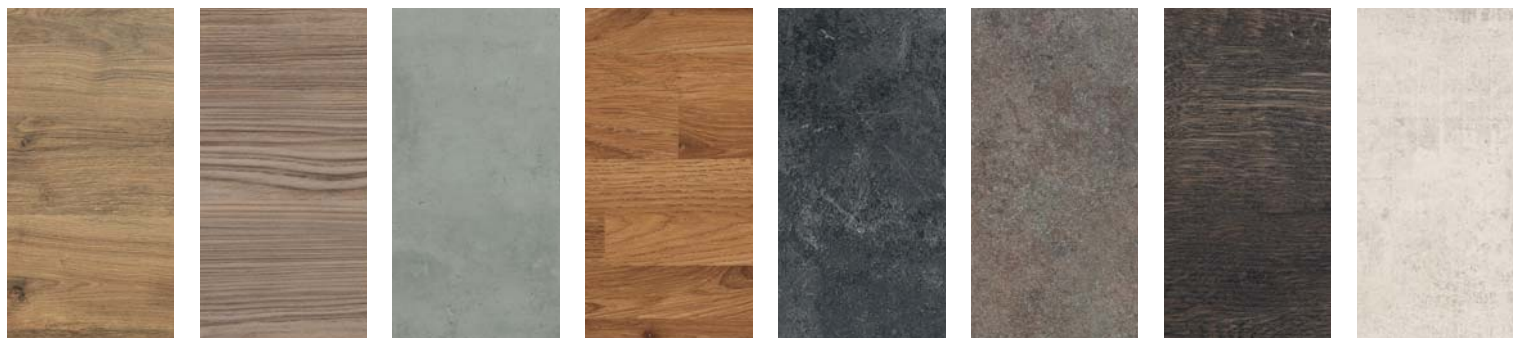

*Chalet Oak*

*Cinnamon*

*Cloudy Cement*

*Colmar Oak*

*Liberty Rock*

*Platinum Metallic*

*Volcanic Ash*

*Woodstone*

## EARTHSTONE SOLID SURFACE WORKTOPS

Earthstone worktops are a great alternative to solid surface worktops such as quartz or granite. They have been designed to give a smooth appearance with inconspicuous joints and edges, while been easy to clean and maintain.

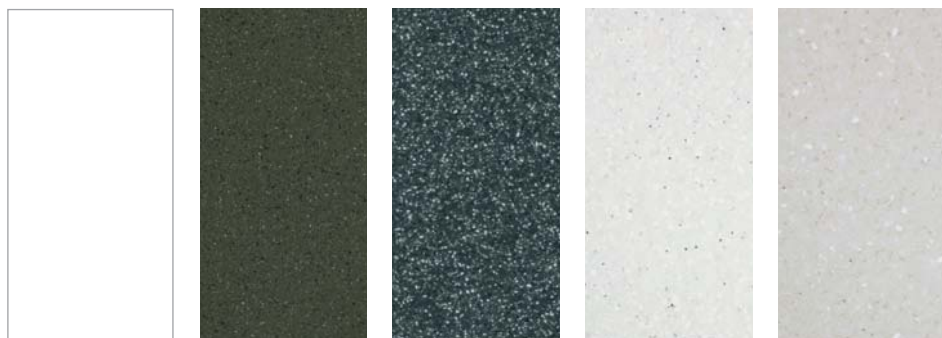

*Glacier White*

*Gold Dust*

*Lava*

*Nordic Melange*

*Pastel Melange*

Please note: All our worksurfaces comply with FIRA Gold Product Certification performance requirements.



# GLASS SPLASHBACKS & UPSTANDS

---

Glass is such a wonderfully versatile material.

Our glass splashbacks and upstands are a great alternative to tiles, but their appeal goes far beyond the practical: they also make a centrepiece for the entire kitchen.



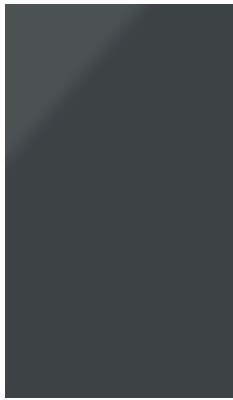

*Anthracite*



*Blue*

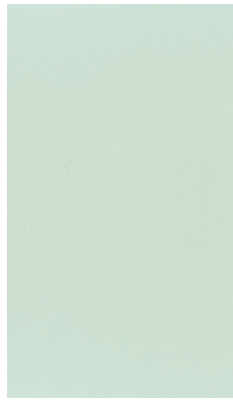

*Bride*



*Bronze*

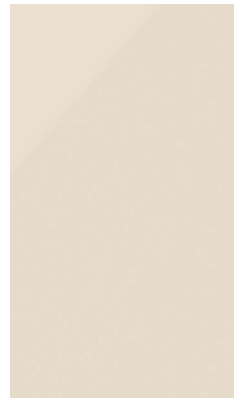

*Cashmere*

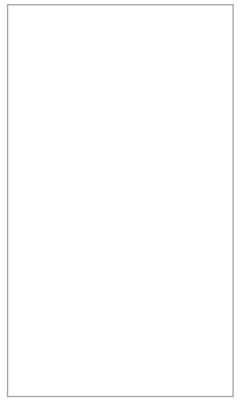

*Chalk White*

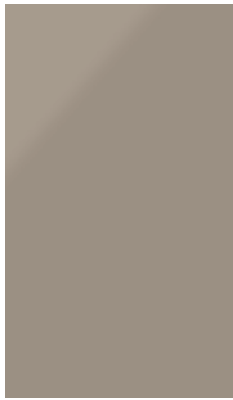

*Dark Stone*

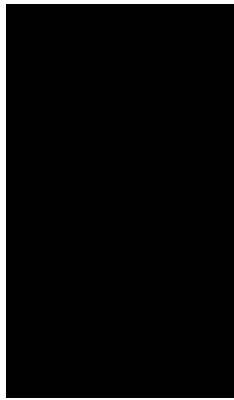

*Ebony*



*Gold*

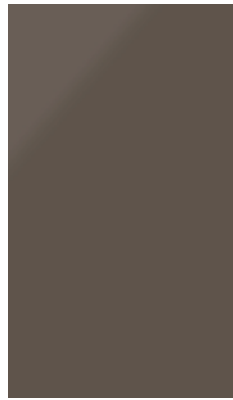

*Lava*

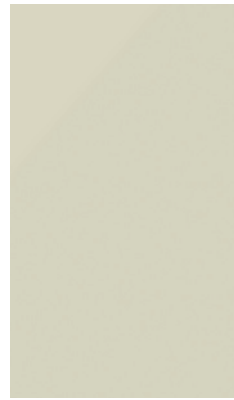

*Light Stone*



*Midnight Stardust*



*Pewter*

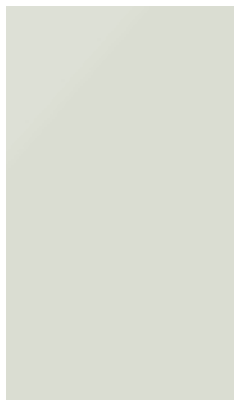

*Platinum*



*Sage*



*Silver*



*White Sparkle*



*Yellow*

Please note: Colour reproduction is as accurate as printing techniques allow.

# LIGHTING & ACCESSORIES

---

The importance of lighting can not be underestimated, it is a crucial element to any kitchen. Lighting can make your kitchen look warm and welcoming or cool and fresh. With our selection of low energy LED lighting you can add the perfect finishing touch to set your kitchen apart.



LED SLS Connex Strip Lights  
*Available in 270mm, 396mm, 524mm and 623mm sizes.*  
LEDSTRIP27WW, LEDSTRIP39WW  
LEDSTRIP52WW, LEDSTRIP62WW



TrioTone Triangle Light  
DELTATRIO  
- COOL, NEUTRAL OR WARM



Illuminated Wall Cabinets  
*300-600 Single Wall and 500-1000  
Bi-fold & Bridging Cabinets*



LED SLS Quadra Light LED  
*Can be used underneath or inside cabinet*  
LEDUCABSLSCW - COOL  
LEDUCABSLSWW - WARM



TrioTone LED light  
*Can be used underneath or inside cabinet*  
- COOL, NEUTRAL OR WARM



HD LED In-Cabinet Strip Light  
PANLIGHT3/4/5/6/8/9/10  
*To suit 300-1000mm drawer and door cabinets*



LED Flexible Strip Lights With Remote And Receiver Pack  
DUOFLEXRC2P

LED Square Plinth Lights  
LEDSQPLINTCW - COOL  
LEDSQPLINTWW - WARM



ALA Illuminated Glass Shelves  
SHELFILU65W - 600MM  
SHELFILU98W - 900MM

Pop-up Socket with USB  
POPUPSOCKU (ALUMINIUM FINISH  
LID)

Pop-up Socket with USB  
POPUPSOCKUSS (STAINLESS  
STEEL LID)

# KESSEBÖHMER PREMIUM STORAGE SOLUTIONS



Our Kesseböhmer premium storage solutions give an added functionality combined with innovative design features, which make the most of every space in the kitchen.



*150mm Two Tier Pull Out & Towel Rail*



*Carousel - Please note this frontal is not available in the Milano kitchen offer*



*Larder Unit Pull Out*



*300 & 400mm Base Unit Pull Out*



*500mm Cranked Pull Out*





*Magic Corner*



*IMove Pull Down Basket*



*Le Mans Corner Unit Storage*



*Linero MosaiQ Midway System - Maxi*



*Linero MosaiQ Midway System - Midi*



*Linero MosaiQ Midway System - Mini*



*Linero MosaiQ Midway Extension Set - Memo Board*



*Linero MosaiQ Midway Extension Set - Magnetic Knife Block*



*Linero MosaiQ Midway Extension Set - Paper Roll Holder*

Linero MosaiQ Midway Systems available in x2 colour choices, Graphite Black or Titanium Grey.

# DRAWER SOLUTIONS

---

Take advantage of every space with a range of innovative drawer options from cutlery trays to drawer organisers.

## CUTLERY TRAYS



*Plastic Cutlery Tray for Atira Drawer Box  
(Silver drawer shown)*



*Metal Cutlery Tray for Atira Drawer Box  
(Silver drawer shown)*



*Timber Cutlery Tray for Atira Drawer Box  
(Anthracite drawer shown)*

## PAN DRAWER ORGANISERS



*Aluminium Pan Drawer Organisers for Atira Drawer Box  
(Silver drawer shown)*



*Orga Flag Pan Drawer Management for Atira Drawer Box  
(Silver drawer shown)*



*Timber Plate Stack  
(Anthracite drawer shown)*



*Timber Deep Pan Drawer Insert for Atira Drawer Box  
(Anthracite drawer shown)*

# TIMBER DRAWER ACCESSORIES



*Roll Dispenser & Timber Cutlery Tray for Atira Drawer Box  
(Silver drawer shown)*



*Timber Knife Block & Cutlery Tray for Atira Drawer Box  
(Anthracite drawer shown)*



*Timber Spice Rack & Cutlery Tray for Atira Drawer Box  
(Anthracite drawer shown)*



*Timber Knife Block, Cutlery Tray & Roll Dispenser for Atira Drawer Box  
(Silver drawer shown)*



*Timber Knife Block & x2 Cutlery Trays for Atira Drawer Box  
(Silver drawer shown)*



*Timber Cutlery Tray & Roll Dispenser for Atira Drawerbox  
(Anthracite Drawerbox shown)*

# WASTE DISPOSAL

Our waste disposal products give you a choice of options to suit your requirements.



500mm Premium Waste Bin BIN564L



600mm Premium Waste Bin BIN685L



Waste Bin SWINGBINCH



400mm Ecobin ECOBIN4



Recycling Bin RECYCLEBIN



400mm Under Sink Waste Bin BIN435L



600mm Ecobin ECOBIN60L



300mm Ecobin ECOBIN3X10



*Fitting precision...*

# SPECIFICATION

---

*The real quality of a kitchen is reflected in its construction. So you'll be pleased to know that our cabinets come with innovative soft close doors and drawers as standard, as well as fully co-ordinated interiors and exteriors. And because they're built to be hard-wearing and practical, they'll stay looking good for years to come.*

# STANDARD CABINET SPECIFICATION

## WALL UNIT SPECIFICATION 18MM CABINET FEATURES

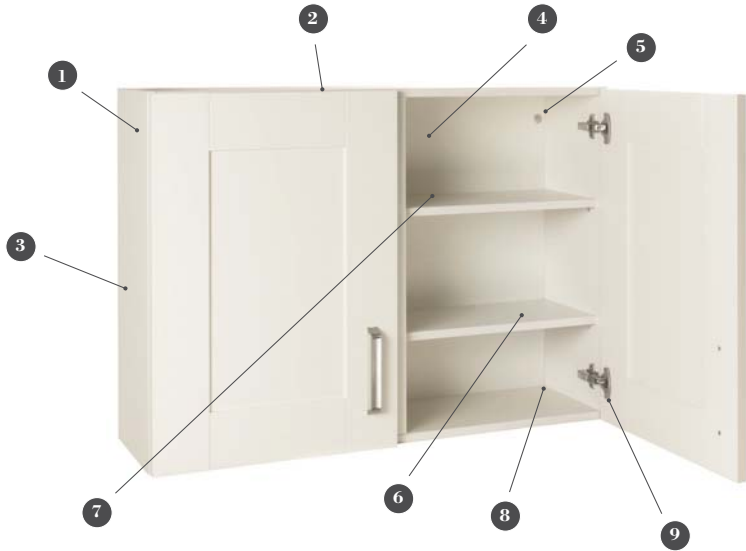

- 1 18mm colour co-ordinated cabinet with matching interior/exterior finish
- 2 3 wall unit heights (561mm, 724mm & 900mm)
- 3 285mm deep cabinet
- 4 3mm hardboard solid back panel
- 5 Concealed fully adjustable wall hanging bracket (*see fig. A*)
- 6 Metal shelf supports (*see fig. D*)
- 7 18mm shelves, glazed cabinets include glass shelves as standard
- 8 Cam and dowel construction
- 9 3-way fully adjustable soft close all metal clip-on hinge (*see fig. C*)

## REPLACEMENT CABINET ENDS

A selection of our ranges are available with frontal matched replacement cabinet ends. This provides 28 different cabinet options and allows you to create a fully co-ordinated kitchen.

Available on both Standard and Premium specifications.

Please speak with your designer for further information.

Cabinet Replacement End shown: White Cabinet with Avola Grey replacement ends.



## BASE UNIT SPECIFICATION 18MM CABINET FEATURES

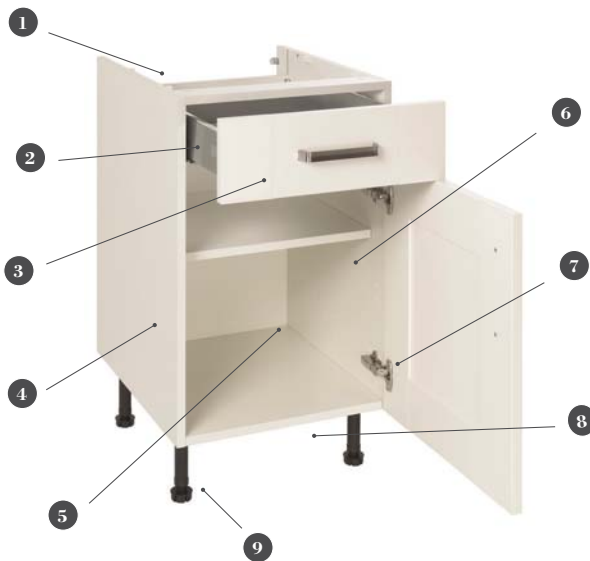

- 1 Removable back with void of 66mm for pipes, etc
- 2 Atira metal drawer box with full extension and soft-closing action available in a choice of Anthracite or Silver (*see Fig. E*)  
Pan drawers have glass sides \*
- 3 3-way fully adjustable drawer front (*see Fig. G*)
- 4 18mm colour co-ordinated cabinet with matching interior/exterior finish
- 5 Cam and dowel construction
- 6 18mm shelves with metal shelf supports (*see Fig. D*)
- 7 3-way fully adjustable all-metal clip-on hinge with soft-close buffer (*see Fig. C*)
- 8 Clip-on continuous plinth with optional plinth dust seal (*order separately*)
- 9 Adjustable legs min. 110mm - max. 180mm



\*Oak drawer box available as upgrade on Classic ranges (*see Fig. H*)

A few features of an In-Frame New England cabinet vary as detailed below:

2 wall unit heights (724mm and 900mm only)

A special width drawer box to allow for the frame (*see Fig. J*)

A special designed 3-way fully adjustable soft close clip on hinge (*see Fig. I*)



Fig. A



Fig. B



Fig. C



Fig. D



# PREMIUM CABINET SPECIFICATION

## WALL UNIT SPECIFICATION 18MM CABINET FEATURES



- 1 18mm colour co-ordinated cabinet with matching interior/exterior finish. Available with a choice of Cashmere, Light Grey or Mid Grey cabinet edging as an optional cabinet edging choice
- 2 3 wall unit heights (561mm, 724mm & 900mm)
- 3 330mm deep cabinet
- 4 8mm one piece solid back panel
- 5 2mm PVC edging to all front cabinet and shelf edges
- 6 Concealed fully adjustable wall hanging bracket (*see fig. B*)
- 7 Metal shelf supports (*see fig. D*)
- 8 18mm shelves, Glazed units include glass shelves as standard
- 9 Cam and dowel construction
- 10 3-way fully adjustable soft close all metal clip-on hinge (*see fig. C*)

## BASE UNIT SPECIFICATION 18MM CABINET FEATURES

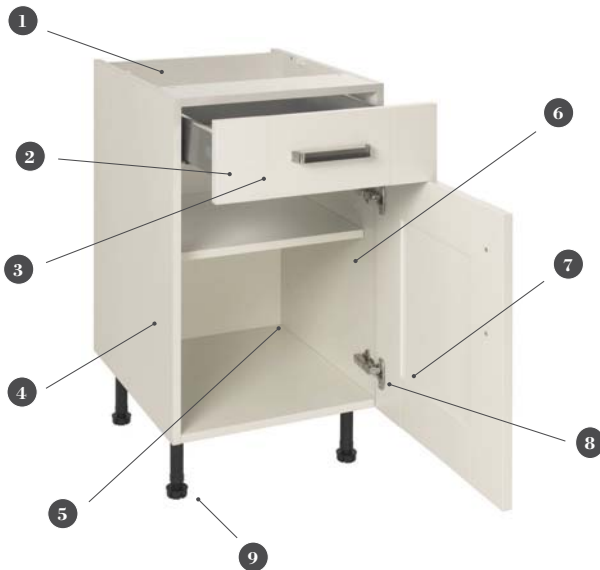

- 1 Removable 15mm solid back with void of 66mm for pipes, etc
- 2 Atira metal drawer box with full extension and soft-closing action, available in a choice of Anthracite or Silver (*see Fig. E*)  
Pan drawers have glass sides \*
- 3 3-way fully adjustable drawer front (*see Fig. G*)
- 4 18mm colour co-ordinated cabinet with matching interior/exterior finish. Available with a choice of Cashmere, Light Grey or Mid Grey cabinet edging as an optional cabinet edging choice
- 5 Cam and dowel construction
- 6 18mm shelves with metal shelf supports (*see Fig. D*)
- 7 3-way fully adjustable all-metal clip-on hinge with soft-close buffer (*see Fig. C*)
- 8 Clip-on continuous plinth with optional plinth dust seal (*order separately*)
- 9 Adjustable legs min. 110mm - max. 180mm

\*Oak drawer box available as upgrade on Classic ranges (*see Fig. H*)



Fig. E



Fig. F



Fig. G



Fig. H



Fig. I



Fig. J

# ABOUT SYMPHONY

---

The Milano kitchen collection is brought to you by Symphony one of the UK's largest suppliers of fitted kitchen, bedroom and bathroom furniture. We have been making kitchens in the UK for over 45 years and are constantly investing in ways to improve our products, service and sustainable manufacturing principles to create the perfect living space.

Each kitchen from Symphony is assured with a 10 year guarantee. Stringent quality control also guarantees you the best quality furniture that's built to last, so you can buy our furniture with complete confidence. Therefore, we are proud that all our ranges achieve FIRA Gold Award certification. The FIRA Gold Award is the ultimate mark of product excellence and completely evaluates quality, fit for purpose and workmanship of ranges.

You'll be pleased to know that we take our environmental responsibilities very seriously. Such as having full FSC® chain of custody for all our furniture. We've gained the quality assurance accreditation BS 9002 Part 2, and subsequently BS EN ISO 14001:2004 independently endorsing our activities to limit the impact on the environment.

---

To ensure the continuous development and improvement of our products, we reserve the right to make changes to the colour, design and descriptions or methods of manufacture of our furniture. Such changes may be made without prior notice and without incurring liability. In many of our products we use wood, a natural living material which will reflect a numerous variety of grains and textures and so variances must be allowed for. Styles that feature timber, PVC, laminates, painted and melamine finishes may incur a slight colour change over the years. The term 'solid timber' applies to door and drawer fronts only. Colour reproduction in this brochure is as accurate as printing techniques will allow. Not every showroom contains these products. Milano is a registered trademark of The Symphony Group PLC. Copyright and all other rights in this brochure and the photographs and other works upon which it is based, are owned by The Symphony Group PLC. No part of the brochure and said photographs and other works may be reproduced or transmitted in any form or by any means (including but not limited to photocopying or sorting in any electronic medium) without the prior express written permission of The Symphony Group PLC. Copyright The Symphony Group PLC 2018.



**Symphony®**  
Creating the perfect living space





by Symphony®



by Symphony®



MY KIND OF  
KITCHEN



0330 333 1555

mkmb.s.co.uk  

OPEN Mon-Fri 7:30-5:30 Sat 7:30-noon

